



1.25Gb/s RoHS Compliant Pluggable BiDi SFP Transceiver

APSB53123xxS40

Product Features

- Up to 1.25Gb/s data links
- Single SC connector
- Hot-pluggable SFP footprint
- 1550nm DFB laser transmitter
- 1310nm InGaAs PIN receiver
- RoHS compliant and Lead Free
- Up to 40km on 9/125um SMF
- Metal enclosure for lower EMI
- Single +3.3V power supply
- Low power dissipation <800mW
- Commercial and industrial operating temperature optional
- SFP MSA SFF-8074i Compliant

Applications

- Gigabit Ethernet
- 1x Fibre Channel

General

ATOP's APSB53123xxS40 Small Form Factor Pluggable (SFP) transceivers are compatible with the Small Form Factor Pluggable Multi-Sourcing Agreement (MSA). The SFP transceivers are high performance, cost effective modules supporting Gigabit Ethernet and 40km transmission distance with SMF. They are RoHS compliant and lead-free.

Product Selection

Part Number	Operating temperature	DDMI
APSB53123CXS40	Commercial	No
APSB53123CDS40	Commercial	Yes
APSB53123IXS40	Industrial	No
APSB53123IDS40	Industrial	Yes

Regulatory Compliance

- ESD to the Electrical PINs: compatible with MIL-STD-883 Method 3015
- ESD to the SC Receptacle: compatible with IEC 61000-4-2
- Immunity compatible with IEC 61000-4-3
- EMI compatible with FCC Part 15 Class B EN55022 Class B (CISPR 22B) VCCI Class B
- Laser Eye Safety compatible with FDA 21CFR 1040.10 and 1040.11 EN60950, EN (IEC) 60825-1,2
- RoHs compliant with 2002/95/EC 4.1&4.2 2005/747/EC

Pin Descriptions

Pin	Symbol	Name/Description	Ref.
1	VeeT	Transmitter Ground (Common with Receiver Ground)	1
2	TX Fault	Transmitter Fault.	
3	TX Disable	Transmitter Disable. Laser output disabled on high or open.	2
4	MOD_DEF(2)	Module Definition 2. Data line for Serial ID.	3
5	MOD_DEF(1)	Module Definition 1. Clock line for Serial ID.	3
6	MOD_DEF(0)	Module Definition 0. Grounded within the module.	3
7	Rate Select	No connection required	
8	LOS	Loss of Signal indication. Logic 0 indicates normal operation.	4
9	VeeR	Receiver Ground (Common with Transmitter Ground)	1
10	VeeR	Receiver Ground (Common with Transmitter Ground)	1
11	VeeR	Receiver Ground (Common with Transmitter Ground)	1
12	RD-	Receiver Inverted DATA out. AC Coupled	
13	RD+	Receiver Non-inverted DATA out. AC Coupled	
14	VeeR	Receiver Ground (Common with Transmitter Ground)	1
15	VccR	Receiver Power Supply	
16	VccT	Transmitter Power Supply	
17	VeeT	Transmitter Ground (Common with Receiver Ground)	1
18	TD+	Transmitter Non-Inverted DATA in. AC Coupled.	
19	TD-	Transmitter Inverted DATA in. AC Coupled.	
20	VeeT	Transmitter Ground (Common with Receiver Ground)	1

Notes:

1. Circuit ground is internally isolated from chassis ground.
2. Laser output disabled on TX Disable >2.0V or open, enabled on TX Disable <0.8V.
3. Should be pulled up with 4.7k - 10kohms on host board to a voltage between 2.0V and 3.6V. MOD_DEF(0) pulls line low to indicate module is plugged in.
4. LOS is open collector output. Should be pulled up with 4.7k – 10kohms on host board to a voltage between 2.0V and 3.6V. Logic 0 indicates normal operation; logic 1 indicates loss of signal.



Pin-out of Connector Block on Host Board

Recommend Circuit Schematic

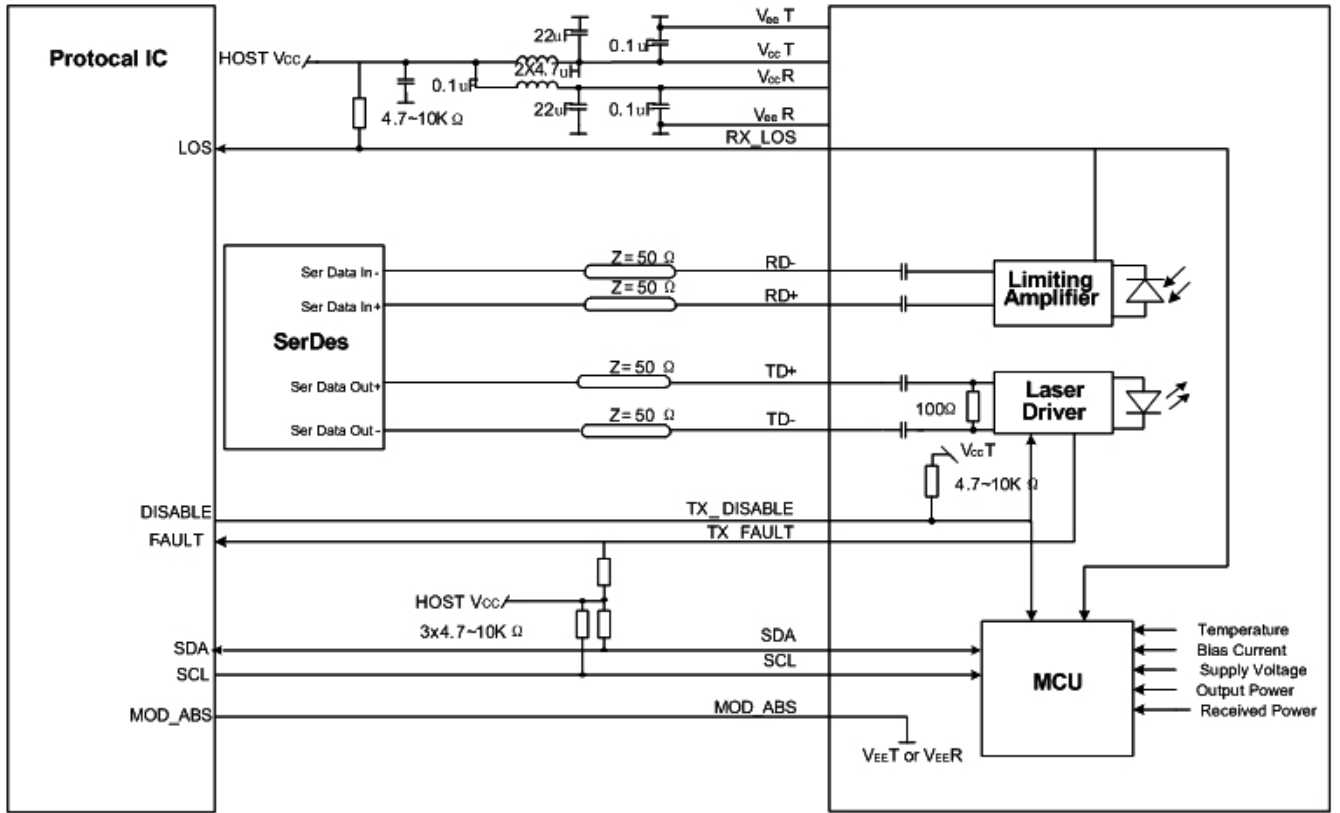

Absolute Maximum Ratings

Parameter	Symbol	Min	Typ	Max	Unit	Ref.
Maximum Supply Voltage	Vcc	-0.5	-	+4.0	V	
Storage Temperature	TS	-40	-	+85	°C	
Operating Humidity	RH	5	-	95	%	

Recommended Operating Conditions

Parameter	Symbol	Min	Typ	Max	Unit	Ref.
Power Supply Voltage	Vcc	3.13	3.30	3.47	V	
Power Supply Current	Icc	-	-	250	mA	
Case Operating Temperature	Tc	0	-	+70	°C	1
	Ti	-40	-	+85		2
Data Rate(Gigabit Ethernet)	-	-	1.25	-	Gbps	
9/125um G.652 SMF	Lmax	-	-	40	km	

Notes:

1. For commercial class product.
2. For industrial class product.

Electrical Characteristics (TOP=25°C, Vcc=3.3Volts)

Parameter	Symbol	Min	Typ	Max	Unit	Ref.
Transmitter						
Input differential impedance	Rin	-	100	-	Ω	1
Single ended data input swing	Vin, pp	250	-	1200	mV	
TX Disable-High	-	Vcc – 1.3	-	Vcc	V	
TX Disable-Low	-	Vee	-	Vee+ 0.8	V	
TX Fault-High	-	Vcc-0.5	-	Vcc	V	
TX Fault-Low	-	Vee	-	Vee+0.5	V	
Receiver						
Single ended data output swing	Vout, pp	300	400	800	mV	2
Data output rise time	tr	-	-	175	ps	3
Data output fall time	tf	-	-	175	ps	3
LOS-High	-	Vcc – 0.5		Vcc	V	
LOS-Low	-	Vee		Vee+0.5	V	

Notes:

1. AC coupled.
2. Into 100 ohm differential termination.
3. 20 – 80 %

Optical Characteristics (TOP=25°C, Vcc=3.3 Volts)

Parameter	Symbol	Min	Typ	Max	Unit	Ref.
Transmitter						
Output Opt. Power	PO	-5	-	0	dBm	1
Optical Wavelength	λ	1530	1550	1570	nm	
Spectral Width	σ	-	-	1	nm	
Side Mode Suppression Ratio	SMSR	30	-	-	dB	
Optical Rise/Fall Time	tr/tf	-	-	260	ps	2
Total Jitter	TJ	-	-	200	ps	
Optical Extinction Ratio	ER	9	-	-	dB	
Receiver						
RX Sensitivity @ 1.25 Gb/s	RSENS	-	-	-25	dBm	3, 4
Maximum Received Power	RXMAX	0	-	-	dBm	
Optical Center Wavelength	λ_C	1275	1310	1350	nm	
LOS De-Assert	LOSD	-	-	-26	dBm	
LOS Assert	LOSA	-40	-	-	dBm	
LOS Hysteresis	-	0.5	-	5	dB	

Notes:

1. Class 1 Laser Safety.
2. Unfiltered, 20-80%. Complies with Gigabit Ethernet eye masks when filtered.
3. Measured with conformance signals defined in FC-PI-2 Rev. 10.0 specifications.
4. Measured with PRBS 2⁷-1 at 10⁻¹⁰ BER.

Mechanical Specifications

ATOP's Small Form Factor Pluggable (SFP) transceivers are compatible with the dimensions defined by the SFP Multi-Sourcing Agreement (MSA).

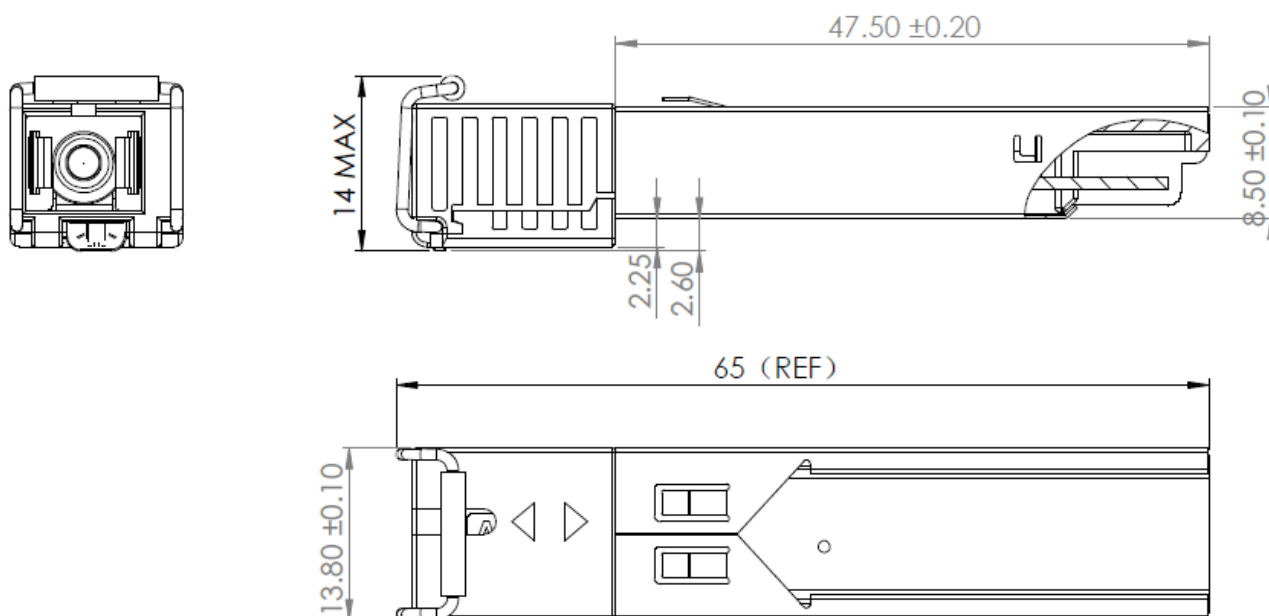

APSB53123xxS40

EEPROM Information

EEPROM memory map specific data field description is as below:

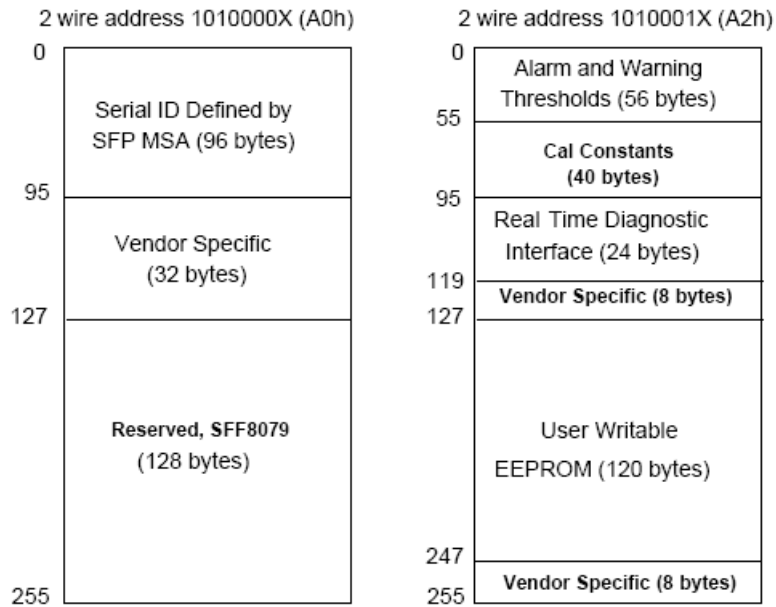

Digital Diagnostic Monitoring Interface

Five transceiver parameter values are monitored. The following table defines the monitored parameter's accuracy.

Parameter	Range	Accuracy	Calibration
Temperature	0 to +70°C (C)	±3°C	Internal
	-40 to +85°C (I)		
Voltage	2.97 to 3.63V	±3%	Internal
Bias Current	0 to 100mA	±10%	Internal
TX Power	-5 to 0dBm	±3dB	Internal
RX Power	-25 to 0dBm	±3dB	Internal

For More Information

ATOP Corporation
 5A of NO.C building of Tongfang information Harbour, langshan Rd, High Tech Park,
 Nanshan District, Shenzhen, China.
 Tel: +86-755-86674946
 Fax: +86-755-86296723
 Email: sales@atoptechnology.com
 Web: www.atoptechnology.com